

# Pons

---

Rodolfo Dordoni  
.11

# Pons



## INTRO

The PONS sofa and table system, designed for Tecno by Rodolfo Dordoni was specially conceived to furnish waiting areas, lounges and managerial environments, but is perfectly at home in domestic settings too. The PONS D011 system is characterised by modularity, easy assembly and extremely flexible components, plus a high level of comfort obtained through the use of different densities of padding.

The system comprises a basic modular structure equipped with a series of universal fittings, to which all the types of seat, backrest and table (120 x 80 cm, 160 x 80 cm, diam. 130 cm) can be attached. Thanks to elements that can be fitted in many different positions, the system is extremely easy to personalise and adapts to the needs of its environment.

The aluminium bases are either polished or painted in matt dark grey. The table tops can be in black laminated FS, matt white or dark grey lacquer, gloss white or dark grey lacquer, white Carrara marble or black Marquina marble.

The system's design features various elements characteristic of Tecno collections (legs and finishes) and therefore integrates perfectly with other Tecno products.

## DESIGNER



Rodolfo Dordoni

# Pons

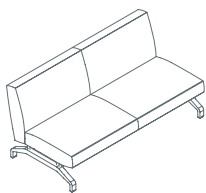

2 seat sofa low backrest, no arms  
**1PN6000:** L 160 D 81 H 74

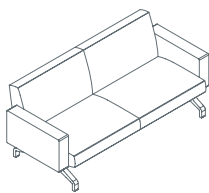

2 seat sofa low backrest, 2 arms  
**1PN6010:** L 182 D 81 H 74

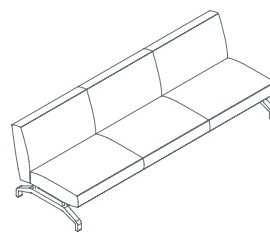

3 seat sofa low backrest, no arms  
**1PN6020:** L 240 P 81 H 74

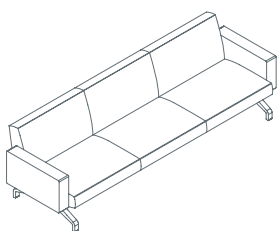

3 seat sofa low backrest, 2 arms  
**1PN6030:** L 262 D 81 H 74

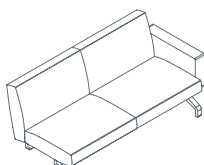

2 seat sofa low backrest, right arm  
**1PN6040:** L 171 D 81 H 74

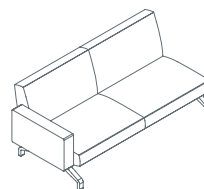

2 seat sofa low backrest, left arm  
**1PN6050:** L 171 D 81 H 74

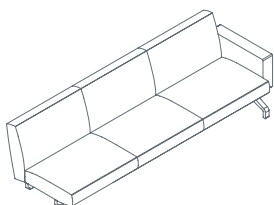

3 seat sofa low backrest, right arm  
**1PN6060:** L 251 D 81 H 74

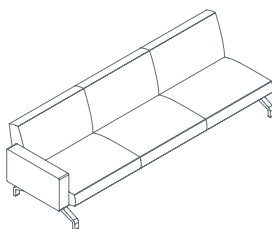

3 seat sofa low backrest, left arm  
**1PN6070:** L 251 D 81 H 74

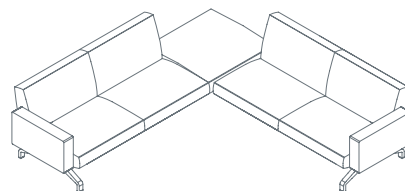

2+2 seat sofa, low backrest, arms and puff  
**1PN6080:** L 251 D 251 H 74

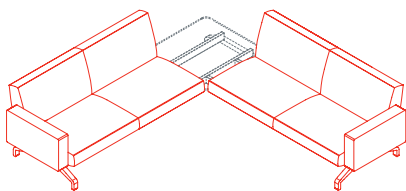

2+2 seat sofa, side table option  
**1PN6090:** L 251 D 251 H 74

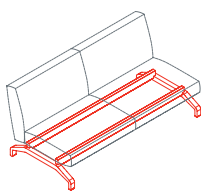

2 seat sofa base  
**1PN6610:** L 160 D 75 H 23

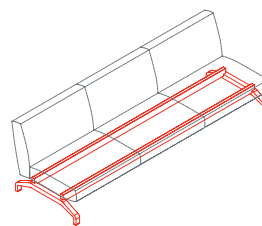

3 seat sofa base  
**1PN6620:** L 240 D 75 H 23

# Pons

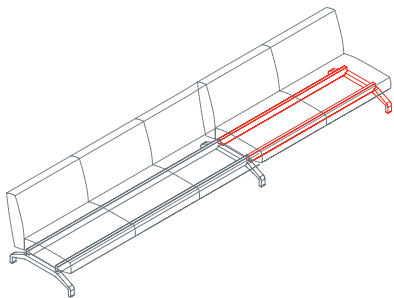

2 seat side sofa base  
**1PN6630**: L 158 D 75 H 23

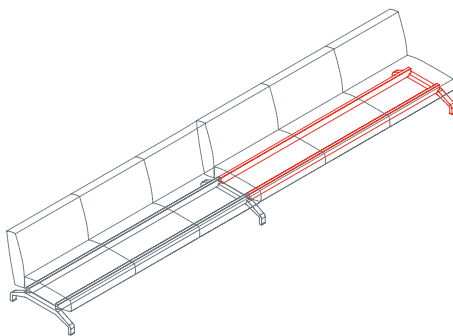

3 seat side sofa base  
**1PN6640**: L 240 D 75 H 23

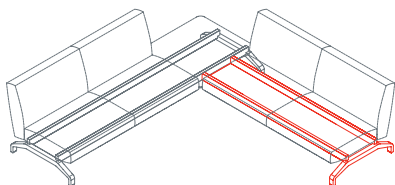

2 seat side sofa base  
**1PN6680**: L 160 P 75 H 23

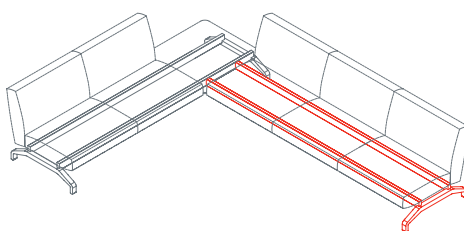

3 seat side sofa base  
**1PN6690**: L 240 P 75 H 23

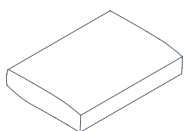

Standard seat  
**1PN6500**: L 80 D 60

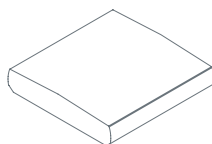

Backless seat  
**1PN6510**: L 80 D 80

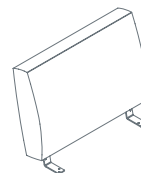

Low backrest  
**1PN6520**: L 80 H 54

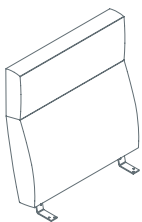

High backrest  
**1PN6530**: L 80 H 78

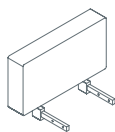

Armrest  
**1PN6540**: L 62 H 34

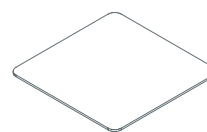
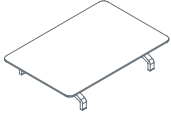
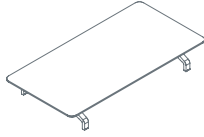

Table top for sofa structure  
**1PN6560**: L 80 D 80

# Pons



Side table 120x80  
1PN4010: L 120 D 80 H 24



Side table 160x80  
1PN4020: L 160 D 80 H 24

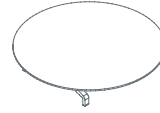

Side table diam. 130  
1PN4030: Ø 130 H 24

## Main heights

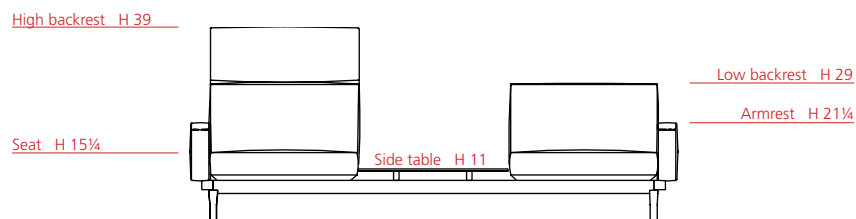

# Pons

## BASES

---



POLISHED ALUMINIUM



DARK GREY MATT PAINTED

## TABLE TOP FOR SOFA STRUCTURE 1PN6560 AND SIDE TABLE 1PN4010, 1PN4020, 1PN4030

---



BLACK SOLID LAMINATE



WHITE MATT LACQUER



DARK GREY MATT LACQUER



WHITE GLOSS LACQUER



DARK GREY GLOSS LACQUER



WHITE CARRARA



BLACK MARQUINA

# Pons

## UPHOLSTERY

---

See the following fabrics and leathers list

## Fabrics 1/4

### TC (Category 01)

---

CUSTOM

CUSTOMER OWN FABRIC

### LANI (Category 02)

---



LIGHT GREY



DARK GREY



BLACK

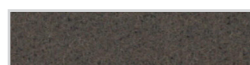

BROWN

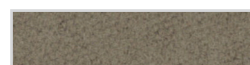

OCHRE



MUSTARD



ORANGE



LIGHT RED



DARK RED



LIGHT BLUE

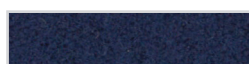

DARK BLUE



POWDER BLUE

# Fabrics 2/4

## FIELD (Category 02)

---



BLACK - WHITE



GREEN GREY



BLACK



CHALK



SAND



YELLOW



RED



PURPLE



BLUE PURPLE



PETROLEUM BLUE



LIGHT GREEN



KIWI GREEN

## METRIC (Category 02)

---

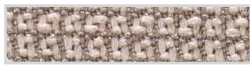

GREEN GREY



SAND



BROWN



MAGENTA



RED



ORANGE



YELLOW



GREEN

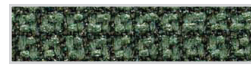

OLIVE GREEN

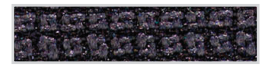

BLACK - GREY



DARK GREY



CLASSIC BLUE

## HOT (Category 02)

---



WHITE

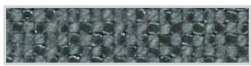

DARK GREY



BLACK



CREME

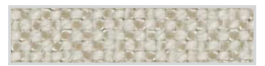

SAND



BROWN



YELLOW



OCBRE YELLOW



ORANGE



PURPLE

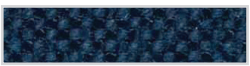

CLASSIC BLUE

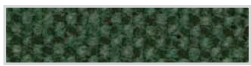

OLIVE GREEN



# Fabrics 3/4

## REMIX (Category 02)

---

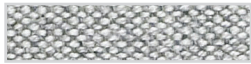

LIGHT GREY



GREY



SAND

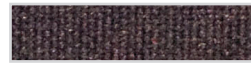

BURGUNDY



COFFE



EARTH



ORANGE



BLUE SKY



PETROLEUM BLUE



AQUAMARINE



LIGHT GREEN

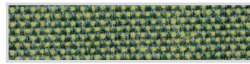

GREEN

## STEELCUT TRIO (Category 03)

---



WHITE - BLACK



WHITE - GREY



WHITE - RED



BEIGE

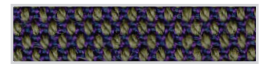

BROWN - PURPLE



OCHRE YELLOW



ORANGE



MAGENTA



ICE

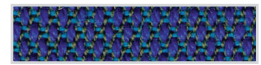

PURPLE - TURQUOIS



GREEN - WHITE

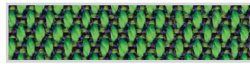

GREEN - PURPLE

## STEELCUT 2 (Category 03)

---



CREME



GREEN GREY



BLACK

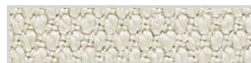

KHAKI



BROWN



YELLOW



ORANGE



RED



AUBERGINE



CLASSIC BLUE



LAWN GREEN



OLIVE GREEN

# Fabrics 4/4

## DIVINA (Category 03)

---



CHALK



BLACK



SAND



YELLOW



ORANGE



RED



MAGENTA



PURPLE



ELETTRIC BLUE

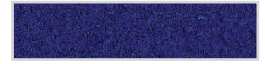

CLASSIC BLUE



LIGHT GREEN



KIWI GREEN

## HALLINGDAL (Category 03)

---



CREME



GREY



BLACK - GREY



BROWN - GREY

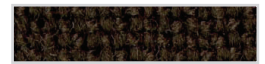

BROWN



OCHRE YELLOW



ORANGE



ORANGE - MARS

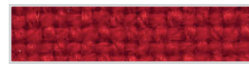

RED

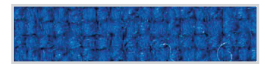

ELETTRIC BLUE



PURPLE

# Leather

## LEATHER (Category 04)

---



WHITE



CHALK



CREME



SAND



SAHANA



KHAKI



HEMP

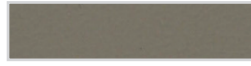

BRACCO



GREY



COCOA



BLACK TEA

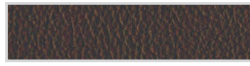

COFFEE



DARK GREY



SLATE GREY



BLACK



MIDNIGHT BLUE



BLUE



DARK GREEN



OLIVE



AVOCADO



CREAM



OCHRE YELLOW



MANGO



GRAPEFRUIT

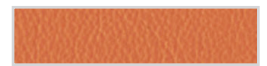

ORANGE



RED



CRIMSON

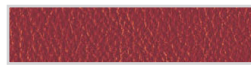

DARK RED



BLACKBERRY



MAUVE